

Deadtime Studies on the Effects of Beam Current Variation

Salina Ali

July 4, 2018

1 Introduction

The data acquisition dead time needs to be computed for each run: the purpose of this analysis was to find a live time correction factor for DVCS rates and check if it was computed correctly. DVCS raw rates can be found using Equation 1, where the total DVCS count rate is normalized by the real time kept by a clock. Specifically, the 103.7 kHz clock located in the DVCS crates in the LHRS¹. A live time correction factor needs to be applied to DVCS rates to account for the missed events output from the data acquisition (DAQ). The live time correction factor applied to DVCS raw rates is our main interest as it will be applied as a correction for the cross section. In general, the live time correction factor can be applied to a given DVCS rate using the DVCS trigger Livetime by using Equation 2, and the deadtime can be recovered from the LT corrected rates by Equation 3.

$$DVCS \text{ raw rate (Hz)} = \frac{DVCS \text{ Count rate}}{Clock (s)} \quad (1)$$

$$DVCS \text{ LT corrected raw rate (Hz)} = \frac{DVCS \text{ Count rate}}{Clock (s) \times DVCS \text{ Trigger Livetime}} \quad (2)$$

$$DVCS \text{ Rate Deadtime} = \frac{DVCS \text{ LT corrected raw rate (Hz)} - DVCS \text{ raw rate (Hz)}}{DVCS \text{ LT corrected raw rate (Hz)}} = DVCS \text{ Trigger Deadtime} \quad (3)$$

$$DVCS \text{ Rate Deadtime (\%)} = \frac{DVCS \text{ LT corrected raw rate (Hz)} - DVCS \text{ raw rate (Hz)}}{DVCS \text{ LT corrected raw rate (Hz)}} \times 100\% \quad (4)$$

¹See https://hallaweb.jlab.org/wiki/index.php/How_to_HRS/_/DVCS for more information about the different clocks and crates in the LHRS.

The clock used to keep the real time of DVCS counts is 103.7 kHz clock is also known as the "steptime" which is used to normalized all counts. The main Trigger Livetime used in this analysis was computed from the scalers counting the signals received from the S2m scintillator and Cerenkov detector in coincidence forming a trigger (S2m&&Cer) which indicates a DVCS event.

To check the livetime (LT) or deadtime (DT), Mongi began by studying the effects of the deadtime with fixed current and varying prescale factors for DVCS rates. He was successful in applying a correction factor for the DVCS scaler-based rates using the MasterOR LT, and was able to recover the DVCS rates better than 1%. The next part of the deadtime analysis was to study the effects of beam current variation with fixed prescale on deadtime from DVCS rates by using run 13418 (Kin 48_4, Spring 2016). We noticed a beam current dependence of 22% per 10 μA and 11% per 5 μA present in the current-LT-normalized DVCS scaler rate (or ARS Valid Rate). To solve the current dependence issue, we began to look at the event-based rates in which we could apply cuts and obtain the DVCS production rate per current. As there was still a current dependence of 13% in DVCS rates normalized by current and livetime (but not present in DIS rates) even with additional cuts via Hashir's Event-Selection Algorithm for DVCS rates, we then looked for ways to remove the random coincidences or accidentals: looking at the time coincidence distribution of photons, electrons and accidentals in the calorimeter clusters. Removing the accidental contribution from the DVCS event-based rates has resolved the current dependence problem for DVCS rates, and they are recoverable within 1% per 10 μA and less than 1% per 5 μA .

A previous analysis of the accidental subtraction used active DIS triggers in the accidental subtraction as there was no known way at the time to subtract the accidental contribution from the DVCS rates. That analysis was performed before applying Hashir's cuts and performing the two-pulse waveform analysis. After the waveform analysis, photons in coincidence with electrons, or DIS and DVCS events, are detected in the clustering process in the calorimeter. Hashir's Good event cuts were applied during the clustering process thus representing a good photon from the calorimeter, and a good electron from the LHRS.

1.1 Beam Current Variation for run 13418

In order to verify the deadtime for DVCS rates, runs that have beam current variation within the same kinematic settings should be recoverable when normalized with the current and livetime. The run currently being used to verify the deadtime and thus recover the DVCS rates is 13418. This run was taken in Spring 2016 and belongs to kinematic 48_4, and has three different currents at 10 μA , 15 μA , 20 μA with a LH_2 target, as shown in Figure 1 through a Beam Current Monitor (BCM) during the run.

Other runs of interest to check the beam current dependence on the deadtime are 12985 (15 μA) and 12901 (10 μA), part of kinematic 48_3.

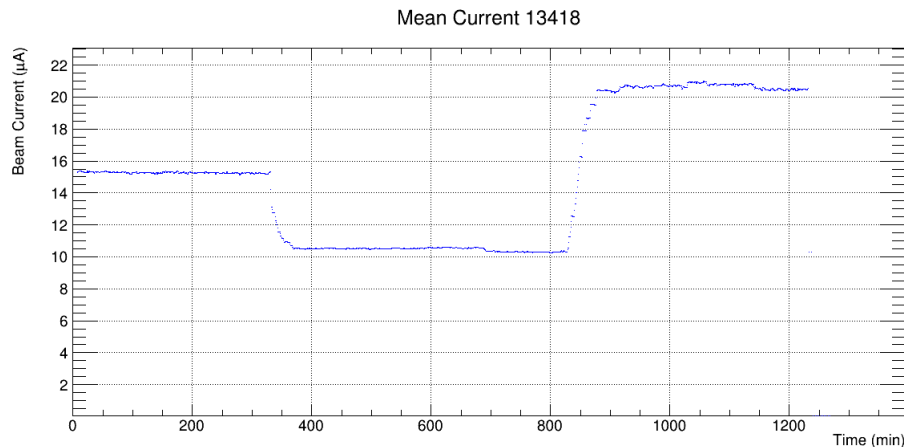

Figure 1: Mean currents shown at 10, 15, 20 μA for run 13418.

1.2 Trigger Setup and Scalers

Scalers corresponding to each active trigger for the run were read out to determine the number of live events and total events. The trigger formed with DVCS rates was the S2m and Cherenkov detectors, with simultaneous signals forming a trigger indicating a DIS or a DVCS event, as shown by Figure 2.

Internal scalers have a "gated_accum_" or "accum_" prefix in the root tree, whereas external scalers have a "cpt" prefix.

2 DVCS Trigger Livetime and Deadtime

The deadtime is defined as the ratio of the number of live events going into the electronics or computers (live) to the total number of events (raw). The deadtime and livetime can be computed for each trigger. Live and raw counts are measured by scaler input in the data stream and raw or counted events are best represented by live and raw internal/external scalers. Equation 5 is used calculate the raw rate. Equation 6 is used to calculate the livetime, and subsequently the deadtime using Equation 7:

$$DVCS \text{ Trigger Scaler Raw rate} = Live \text{ rate} \times \frac{1}{1 - Deadtime} \quad (5)$$

$$DVCS \text{ Trigger Scaler Livetime} = \frac{Live \text{ scaler rate}}{Raw \text{ scaler rate}} \quad (6)$$

$$DVCS \text{ Trigger Deadtime} = 1 - DVCS \text{ Trigger Livetime} \quad (7)$$

$$Deadtime(\%) = (1 - Livetime) * 100 \quad (8)$$

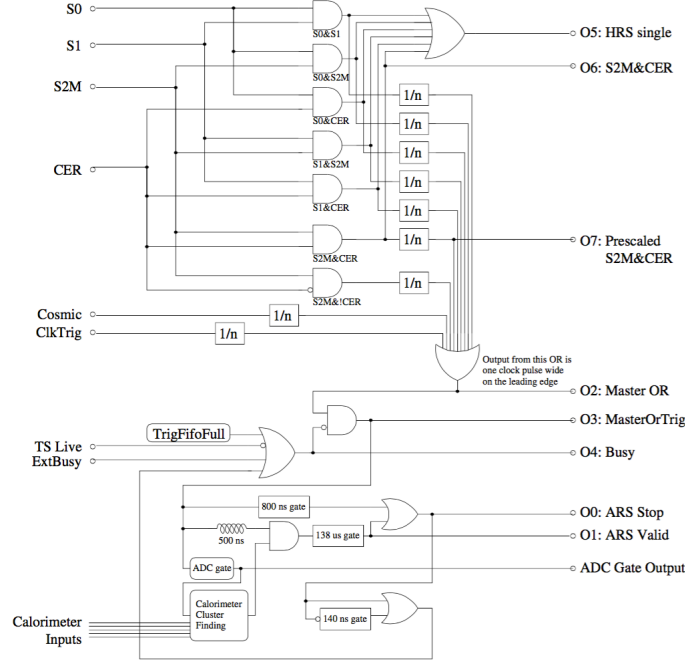

Figure 2: Internal trigger setup for the DVCS-3 experiment in Hall A, Spring 2016

One may ask, which triggers can and should we use for the livetime or deadtime correction for DVCS rates? From Mongi's studies in the past, the main DVCS trigger $S2m\&\&Cer$ could be used as we are studying DVCS production rates. The scalers in the root tree to calculate the livetime for $S2m\&\&Cer$ is shown for internal scalers in Equation 9 and in Equation 10 for external scalers². Both external and internal scalers (used for $S2m\&\&Cer$ LT too) are in agreement within 1%: we can use either for the LT calculation. This was also demonstrated in Mongi's previous studies³.

$$S2m\&\&Cer\ LT\ (internal) = \frac{cptS2M_CER_Live}{cptS2M_CER} \quad (9)$$

$$S2m\&\&Cer\ LT\ (external) = \frac{gated_accum_dvcs_scaler_15}{accum_dvcs_scaler_15} \quad (10)$$

²More details about scalers and corresponding leaves in the root tree can be found in my wiki page: http://www.vsl.cua.edu/cua_phy/index.php/MainPage:Nuclear:DVCS-3#Trigger_Diagrams.

³Mongi's elog entry here for internal and external scaler agreement: <https://hallaweb.jlab.org/dvcslog/12+GeV/415>

Rates and LT	0 (μA)	10.61 (μA)	15.32 (μA)	20.53 (μA)
S2m&Cer live (Hz)	13.17	120.7	181.4	253.4
S2m&Cer raw (Hz)	13.25	123.0	186.7	264.0
Master OR live (Hz)	19.79	124.8	187.0	260.6
Master OR raw (Hz)	19.90	127.4	192.8	272.0
S0 live (Hz)	128.4	1910	2751	3659
S0 raw (Hz)	129.2	1943	2825	3795
S2m live (Hz)	344.4	6039	8704	1.160E4
S2m raw (Hz)	346.2	6141	8927	1.202E4
S2m $\frac{live}{raw} = LT$	0.9948	0.9835	0.9750	0.9647
S0 $\frac{live}{raw} = LT$	0.9944	0.9832	0.9737	0.9641
Master OR $\frac{live}{raw} = LT$	0.9944	0.9796	0.9700	0.9580
S2m&Cer $\frac{live}{raw} = LT$	0.9936	0.9811	0.9715	0.9598

Table 1: Table showing raw and live rates from triggers and livetimes for S2m&&Cer, Master OR, S0, S2m. All livetimes are pedestal subtracted, e.g events considered only when beam current is $< 0.8 \mu A$ in run 13418 and subtracted during the run. We used S2m&&Cer LT as our Livetime correction for DVCS rates.

We could have used the livetime correction from S0, S2m, and Master OR as they have a livetime agreement better than $1\%^4$. Updated rates and livetimes for these triggers are shown in Table 1. The different livetimes corresponding to the ones in Table 1 are shown as a function of the beam current in Figure 3.

- S0 with live/raw scalers $\frac{gated_accum_dvcs_scaler_s0}{accum_dvcs_scaler_s0} = S0\ LT$
- S2m with live/raw scalers $\frac{gated_accum_dvcs_scaler_s2}{accum_dvcs_scaler_s2} = S2m\ LT$
- MasterOR with live/raw scalers $\frac{gated_accum_dvcs_scaler_24}{accum_dvcs_scaler_24} = MasterOR\ LT$

The studies on beam current variation for run 13418 began by using the scaler for the autovalidation rate (ARS Valid Rate) representing the DVCS production rate in Hz^5 , as shown in Equation 11. However, the ARS Valid rate (DVCS scaler rate) after normalization with current and S2m&&Cer LT was still scaled to the current. As a result, the study shifted gear to look at the data from run 13418 event-by-event and apply cuts to select good DVCS events as shown in Equation 12, in addition to hardware and software corrections to recover the rates to better than 5% .

$$DVCS\ Scaler\ Raw\ Rate\ (Hz) = \frac{cptARSValid}{103.7\ kHz\ clock\ steptime} \quad (11)$$

⁴See Mongi's elog entry for more information on different trigger livetimes and agreement: <https://hallaweb.jlab.org/dvcslog/12+GeV/437>

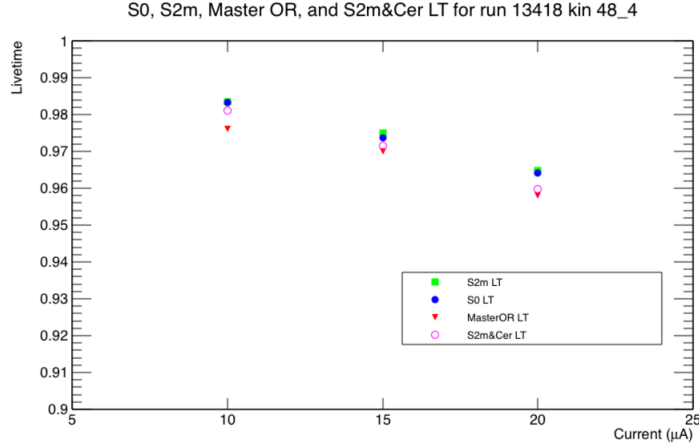

Figure 3: Livetimes of S2m, S0, Master OR and S2m&Cer shown as a function of mean currents at 10, 15, 20 μA for run 13418.

$$DVCS \text{ Event-based Raw Rate (Hz)} = \frac{GoodEventCut \& TDC cut \& (triggerPatternWord \& 0x00100 == 256)}{103.7 \text{ kHz clock steptime}} \quad (12)$$

The livetime and the 103.7 Hz clock (located in the LHRS in the DVCS crates) steptime is used to normalize the DVCS rates as shown in Equation 12. This was also done with the previous DVCS scaler-based rate (autovalidation rate from ARS Valid scaler)⁵ calculations as shown in Equation 11.

3 DVCS Event-based rates + new cuts

Hashir's DVCS3 Event Selection Algorithm⁶ was used to apply good electron cuts in both the DVCS rates and accidental calculations. The "GoodEventCut" was applied to all rates and includes:

- single tracking cut (L.tr.n==1) and cuts on the u1,v1,u2,v2 planes of the Vertical Drift Chamber (VDC)
 - $u1 == 1 \& \& u2 == 1 \& \& v1 == 1 \& \& v2 == 1$
 - $(u1 > 1 \& \& u2 == 1 \& \& v1 == 1 \& \& v2 == 1) || (u1 == 1 \& \& u2 > 1 \& \& v1 == 1 \& \& v2 == 1) || (u1 == 1 \& \& u2 == 1 \& \& v1 > 1 \& \& v2 == 1) || (u1 == 1 \& \& u2 == 1 \& \& v1 == 1 \& \& v2 > 1)$

⁵More info on the previous DVCS scaler-based or ARS Validation rate is in Mongi's elog entry here: <https://hallaweb.jlab.org/dvcslog/12+GeV/436>.

⁶More information on Hashir's cuts is in the elog entry here: <https://hallaweb.jlab.org/dvcslog/12+GeV/487>.

	0 (μA)	10.61 (μA)	15.32 (μA)	20.53 (μA)
S2m&Cer LT	0.9936	0.9811	0.9715	0.9598
Event Rate (Hz)	17.78	103.7	166.0	244.4
Event Rate&Tracking Cut (Hz)	0.5410	53.49	83.16	116.1
Event Rate&Tracking&TDC&Cer (Hz)	0.3570	49.01	76.19	106.6
Event Rate&Tracking&TDC&Cer&PR&VtxCut (Hz)	0.2642	33.33	51.35	72.40
Event Rate&GoodEventCut&TDC (Hz)	0.1650	20.69	31.75	44.86
GoodEventCut&TDC&DIS (Hz)	n/a	13.66	19.48	26.09
ARS Valid rate (Hz)	16.61	96.40	154.3	227.4
GoodEventCut&TDC&DVCS (Hz)	n/a	20.69	31.75	44.85

Table 2: Table for run 13418 showing all raw rates with all cuts and corrections applied. GoodEventCut includes Track&TDC&Cer&PR&VtxCut&Rfunction cuts. All rates are pedestal subtracted, e.g subtracting events considered only when beam current is $< 0.8 \mu A$ from rates. All raw rates are normalized with the 103.7 kHz clock from LHRS in DVCS crate. DIS rates have GoodEventCut & TDC & DIS (triggerPatternWord) cuts applied, DVCS rates have GoodEventCut & TDC & DVCS (triggerPatternWord) cuts applied and have units Hz .

- Cherenkov detector photoelectron channel peak or Cherenkov amplitude sum: $L.cer.asum_c > 150$ (accepting more than 1.5 photoelectrons).
- Pion Rejector cut (PR)
 - $L.prl1.asum_c$: PR layer 1 $> 60\%$ of full energy peak
 - $L.prl2.asum_c$: PR layer 2 $> 20\%$ of full energy peak
- Target Vertex Cut for Spring 2016 data: corrects for scattering against aluminum walls of target e.g. target vertex is set to be 6.5 cm from target center
- Alexa’s R Function cut for kin 48_4

Additionally, cuts on the Time-to-Digital Converter (TDC) and triggerPatternWord were made:

- TDC cut: $tdc_val[27] - tdc_val[7]/10 < -24$
- TriggerPatternWord cut for DIS: $TPW \& 0x00080 == 128$
- TriggerPatternWord cut for DVCS: $TPW \& 0x00100 == 256$

In addition to Hashir’s good event cuts, another correction for missed events after passing the tracking cuts must be applied to the whole analysis. For kinematic 48_4, this correction factor was 1.06 and was applied to the number of events contained in all the rates. All new cuts and rates are shown in Table 2.

No cuts ($Hz/\mu A$)	n/a	9.773	10.83	11.90
Tracking Cut ($Hz/\mu A$)	n/a	5.042	5.429	5.653
Tracking&TDC&Cer ($Hz/\mu A$)	n/a	4.619	4.973	5.190
Tracking&TDC&Cer&PR&VtxCut ($Hz/\mu A$)	n/a	3.141	3.352	3.527
GoodEventCut&TDC ($Hz/\mu A$)	n/a	1.950	2.073	2.185
$\frac{GoodEventCut&TDC&DIS}{I}$ ($Hz/\mu A$)	n/a	1.288	1.272	1.271
$\frac{GoodEventCut&TDC&DIS}{I \times S2m \text{ Cer } LT}$ ($Hz/\mu A$)	n/a	1.313	1.310	1.324
$\frac{ARS \text{ Valid Rate}}{I}$ ($Hz/\mu A$)	n/a	9.086	10.07	11.08
$\frac{ARS \text{ Valid Rate}}{I \times S2m \text{ Cer } LT}$ ($Hz/\mu A$)	n/a	9.262	10.37	11.54
$\frac{ARS \text{ Valid Rate}}{I}$ ($Hz/\mu A$)	n/a	9.086	10.07	11.08
$\frac{ARS \text{ Valid Rate}}{I \times S2m \text{ Cer } LT}$ ($Hz/\mu A$)	n/a	9.262	10.37	11.54
$\frac{GoodEventCut&TDC&DVCS}{I}$ ($Hz/\mu A$)	n/a	1.950	2.073	2.185
$\frac{GoodEventCut&TDC&DVCS}{I \times S2m \text{ Cer } LT}$ ($Hz/\mu A$)	n/a	1.988	2.135	2.276

Table 3: Table for **run 13418** showing all pedestal subtracted rates normalized by current and livetime with all cuts and corrections applied. GoodEventCut includes Track&TDC&Cer&PR&VtxCut&Rfunction cuts. All raw rates are normalized with the 103.7 kHz clock from LHRS in DVCS crate. DIS rates have GoodEventCut & TDC & DIS (triggerPatternWord) cuts applied, DVCS rates have GoodEventCut & TDC & DVCS (triggerPatternWord) cuts applied and have units Hz . DIS normalized rates had a $< 1\%$ agreement per $10 \mu A$, and DVCS normalized rates had a 13% agreement per $10 \mu A$ and a 6 to 7% agreement per $5 \mu A$. Note that the normalized DIS rates have almost no current dependence, whereas the DVCS normalized rates do.

4 Waveform Analysis and Clustering

Waveform analysis is a method that works to extract the amplitude of a pulse coming from the ARS (Analog Ring Sampler), which is used to sample events and record from active triggers. The analysis was done using libraries unique to DVCS such as TARSWave.h and TEventCalo.h. The waveform analysis detects pulses coming from the ARS based on the energy of photons hitting blocks in the calorimeter, and fits to a baseline one or a two-pulse wave using the χ^2 value. Depending on the χ^2 , the waves are fit to a baseline, one pulse or two pulse.

After the two-pulse fit from the waveform analysis, the clustering of the blocks in the DVCS calorimeter determined the "good" photon. All cuts and corrections were applied during the clustering, including Hashir's good electron cuts for DVCS events.

5 Accidental Studies

The ultimate goal of this analysis was to further reduce the current dependence on the LT and current normalized dvcs rates by obtaining an accidental rate from the coincidence and accidental timing in the calorimeter clusters, and "subtract" it from DVCS event rates (shown in Table 2). The clustering of the blocks in the calorimeter provided time spectra based on a clustering energy threshold set for each block, $E_\gamma > 1.5$ GeV or the "triggerSim" threshold⁷.

Accidentals make up most of the background and are present in the rates. Accidentals are any photons and electrons from the DVCS calorimeter and LHRS that are not in coincidence. Real coincidences occur when photons and electrons are simultaneously in coincidence with one another, with each coincidence considered a "signal", also known as a DVCS event. Accidentals or random coincidences scale with the beam current (μA) squared (I^2) shown in Equation 14 where a is a constant. The signal or real coincidences scale directly with the beam current shown in Equation 13 where b is a constant. The beam current dependence for the signal and accidentals are shown by the relationship in Equation 15.

$$\text{Signal (ns)} = a \times I \tag{13}$$

$$\text{Background (ns)} = b \times I^2 \tag{14}$$

$$\frac{\text{Signal}}{\text{Background}} = \frac{a \times I}{b \times I^2} = \frac{a}{b \times I} \tag{15}$$

⁷Previously this threshold was set to 1.0 GeV, but after Mongi and Frederic's Elastic Trigger calibration for each kinematic (December 2017), the noted energy threshold for kinematic 48_4 was used. See the elog entry here: <https://hallaweb.jlab.org/dvcslog/12+GeV/489> for more information.

5.1 Coincidence Time Selection: Main Coincidence and Accidental Windows

The main coincidence peaks that are centered at $[-2,2]$ and $[-3,3]$ represents the photons, electrons and accidentals, as shown in Figure 4 for all three currents. Taking the area under the coincidence peak gives the background which contains both the real coincidences and accidentals, as shown in Equation 17. Equation 16 is used to determine the signal or real coincidences by subtracting the background.

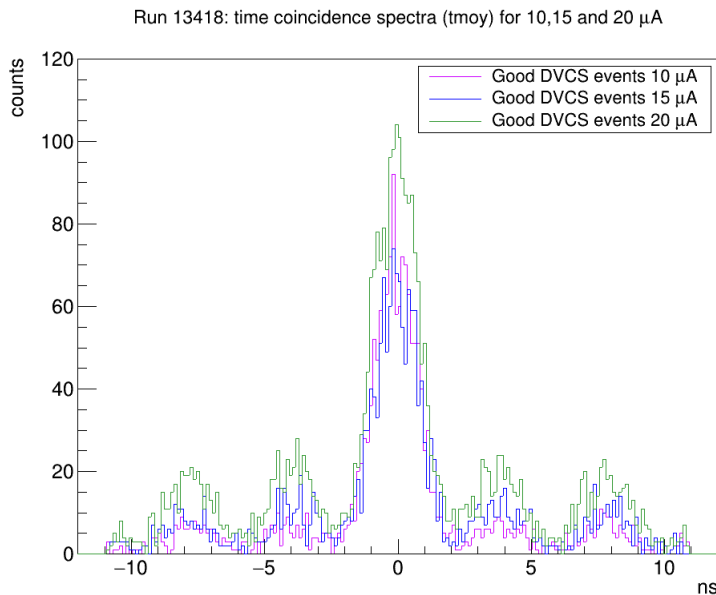

Figure 4: DVCS time coincidence spectra at all three different currents, with all events passing the Good Event cut in the clustering. The events in this range of $[-3,3]$ is equivalent to the total amount of hits in the calorimeter including photons, electrons and background. The accidentals must be chosen in the same range as the main coincidence peak of 6 ns, such as windows at $[5,11]$ and $[-11,-5]$.

$$\text{Signal or real coincidences} = \text{Integral of main coincidence peak of 4 (or 6) ns} - \text{Integral of accidental 4 (or 6) ns peak} \quad (16)$$

$$\text{Integral of main coincidence peak} = \text{Background} \quad (17)$$

To account for higher statistical uncertainty than in past analyses using the 4 ns windows, the accidental windows were extended to 6 ns and compared. Any

6 ns window from [-11,11] could have been chosen with respect to the peaks, but for statistical purposes different scales of windows were chosen, compared and averaged. Accidental windows were in the range [-11,-5] and [5,11] for a 6 ns range, and [-10,-6] and [6,10] for a 4 ns range.

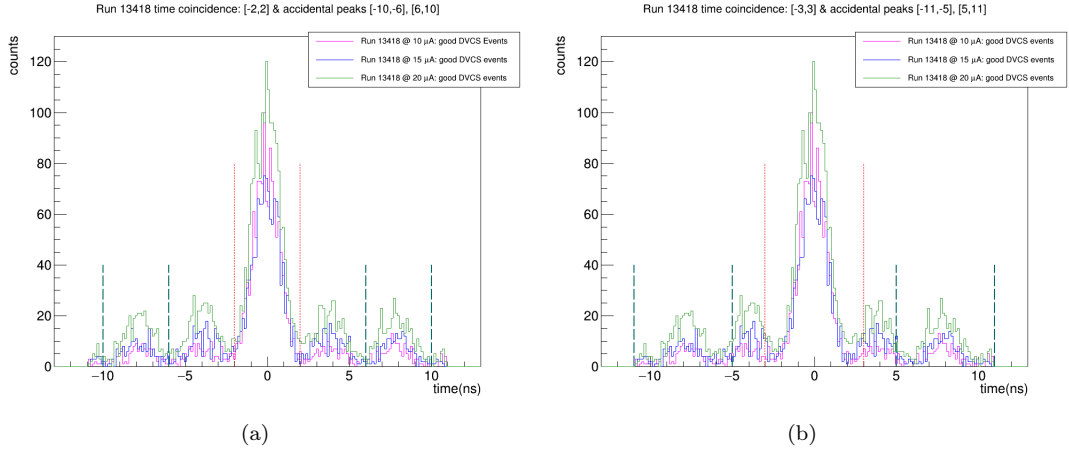

Figure 5: Time coincidence spectra for DVCS events from **run 13418**, with all events passing the Good Event cut in the clustering. Accidental peaks (red) that are 4 ns wide are in the range [-10,-6] and [6,10] for 10, 15, 20 μA . Accidental peaks (red) that are 6 ns wide are in the range [-11,-5] and [5,11] for 10, 15, 20 μA . The integral over this range has the total amount of hits including photon, electron and background. Accidentals shown in red at [-10,-6] for 10, 15, 20 μA .

Using the relationship between the signal, background and current in Equation 15, we can derive the signal to background ratio using Equation 18.

$$\frac{Signal}{Background} = \frac{Background - Accidental\ peak}{Background} \quad (18)$$

The ratios of the real coincidences (signal) to the background were calculated using Equation 18 for each current. Results are in the "Avg 6 ns acc sig/back ratio" and "Avg 4 ns acc sig/back ratio" rows for each current shown in Table 4.

The different scaled windows in Table 4 are presented to demonstrate higher statistical uncertainty in the 4 ns windows (including less good events per ns) as compared with the extended 6 ns accidental windows (including more good events per ns). The events in the [-2,2] range in the coincidence spectrum are used together with the 4 ns mean of [-10,-6] & [6,10] to obtain the signal to background ratios via Equation 18 (shown in Table 4). The results in the 6 ns, [5,11] & [-11,-5] mean row were calculated using 18 with the 6 ns main coincidence window and the mean value of events in [6,10] and [-10,-6] (shown in Table 4). Extending the accidental and main coincidence windows from 4 ns and 6 ns is best representative of DVCS production events as it includes the full main coincidence and accidental peaks.

Time coincidence window cuts	10 μA	15 μA	20 μA
Raw time coincidence window [-11,11]	1920	2126	3530
4 ns, [-2,2] main coincidence window	1324	1225	1843
4 ns, [-2,2] main coincidence window: <i>events/ns</i>	331.0	306.3	460.8
6 ns, [-3,3] main coincidence window	1384	1320	2006
6 ns, [-3,3] main coincidence window: <i>events/ns</i>	230.7	220.0	334.3
6 ns, [-11,-5] accidental window	164.3	228.9	451.6
6 ns, [-11,-5] accidental window: <i>accidentals/ns</i>	27.38	38.16	75.26
4 ns, [-10,-6] accidental window	135.7	181.3	372.1
4 ns, [-10,-6] accidental window: <i>accidentals/ns</i>	33.92	45.32	93.02
6 ns, [5,11] accidental window	173.8	236.4	449.4
6 ns, [5,11] accidental window: <i>accidentals/ns</i>	28.97	39.40	79.41
4 ns, [6,10] accidental window	145.2	202.5	384.8
4 ns, [6,10] accidental window: <i>accidentals/ns</i>	36.31	50.62	96.20
6 ns, [5,11] & [-11,-5] mean	169.1	232.7	450.5
6 ns, [5,11] & [-11,-5] mean: <i>mean accidentals/ns</i>	28.18	38.78	75.08
4 ns, [-10,-6] & [6,10] mean	140.5	191.9	378.4
4 ns, [-10,-6] & [6,10] mean: <i>mean accidentals/ns</i>	35.11	47.97	94.61
6 ns mean accidentals & coincidences in [-3,3]: <i>signal/background</i>	0.8779	0.8237	0.7754
4 ns mean accidentals & coincidences in [-2,2]: <i>signal/background</i>	0.8939	0.8434	0.7947

Table 4: Table for **run 13418** showing scaled accidentals/ns of the accidental windows and the events/ns of the coincidence windows of 4 ns at [-2,2] and 6 ns at [-3,3] rounded to the nearest significant figure. The discrepancy between the two main coincidence windows ranges from 32 % to 36 % with decreasing current. The discrepancy between the mean of the two accidental windows ranges from 21 % to 23 % with increasing current. The windows chosen for the correction of DVCS rates were the 6 ns main coincidence [-3,3], with the 6 ns mean accidentals. The scaling of events per ns did not affect the DVCS calculation as we only use the signal/background ratios to perform the subtraction of accidental contributions from DVCS rates.

I (μA)	DVCS Raw	$\frac{DVCS\ Raw}{I}$	$\frac{DVCS\ Raw}{I \times S2m \& Cer\ LT}$	$\frac{4\ ns\ signal}{4\ ns\ background}$	$\frac{DVCS\ Raw \times \frac{4\ ns\ signal}{4\ ns\ background}}{I \times S2m \& Cer\ LT}$	$\frac{6\ ns\ signal}{6\ ns\ background}$	$\frac{DVCS\ Raw \times \frac{6\ ns\ signal}{6\ ns\ background}}{I \times S2m \& Cer\ LT}$
10.61	20.69	1.950	1.988	0.8939	1.777	0.8779	1.745
15.32	31.75	2.073	2.135	0.8434	1.800	0.8237	1.758
20.53	44.85	2.185	2.276	0.7947	1.809	0.7554	1.765

Table 5: Table for DVCS rates for **run 13418** and have GoodEventCut & TDC & DVCS (triggerPatternWord) cuts applied and normalized with the S2m & Cer livetime, and have units ($\frac{Hz}{\mu A}$). DVCS normalized rates had a 13% agreement per 10 μA and a 7% agreement per 5 μA . The DVCS 4 ns signal/background ratios applied to the DVCS normalized rates result in a discrepancy of 1.8% per 10 μA and < 1.3% per 5 μA . The DVCS 6 ns signal/background ratios applied to the DVCS normalized rates result in a discrepancy of 1.1% per 10 μA and 0.74% per 5 μA .

5.2 Signal and background for DVCS Events

The signal (from the 6 ns main coincidence [-3,3]) to background (from accidental windows [-11,-5] and [5,11] accidentals averaged) ratio in Table 4 computed using Equation 18 was multiplied by the DVCS raw rates (Hz) from Table 2. Then we normalized each *DVCS raw rate* (Hz) $\times \frac{signal}{background}$ ratio to its corresponding beam current and S2m&&Cer Livetime as summarized in Equation 19.

$$DVCS\ normalized\ rate\ corrected = \frac{DVCS\ rate\ (Hz) \times (DVCS\ signal/background\ 4ns\ or\ 6\ ns)}{I\ (\mu A) \times S2m \& Cer\ LT} \quad (19)$$

In general, DVCS rates were corrected using the format in Equation 19. More detailed calculations of the DVCS corrected rates for 10, 15 and 20 μA are shown in Equations 20, 21 and 22. By the subtraction of the accidental contribution via application of the signal to background ratio using the 6 ns windows to the DVCS normalized rates, we were able to achieve a 1% discrepancy per 10 μA and a <1% discrepancy per 5 μA for DVCS normalized rates in run 13418. A comparison of rates before the accidental correction and after is shown in Figure 6, along with a comparison of the previously analyzed ARS valid rates.

$$DVCS\ corrected\ normalized\ rate\ at\ 10\ \mu A = \frac{20.69\ Hz \times 0.8723}{10.61\ \mu A \times 0.981} = 1.745\ \frac{Hz}{\mu A} \quad (20)$$

$$DVCS\ corrected\ normalized\ rate\ at\ 15\ \mu A = \frac{31.75\ Hz \times 0.8237}{15.32\ \mu A \times 0.971} = 1.758\ \frac{Hz}{\mu A} \quad (21)$$

$$DVCS\ corrected\ normalized\ rate\ at\ 20\ \mu A = \frac{42.85\ Hz \times 0.7554}{20.53\ \mu A \times 0.960} = 1.765\ \frac{Hz}{\mu A} \quad (22)$$

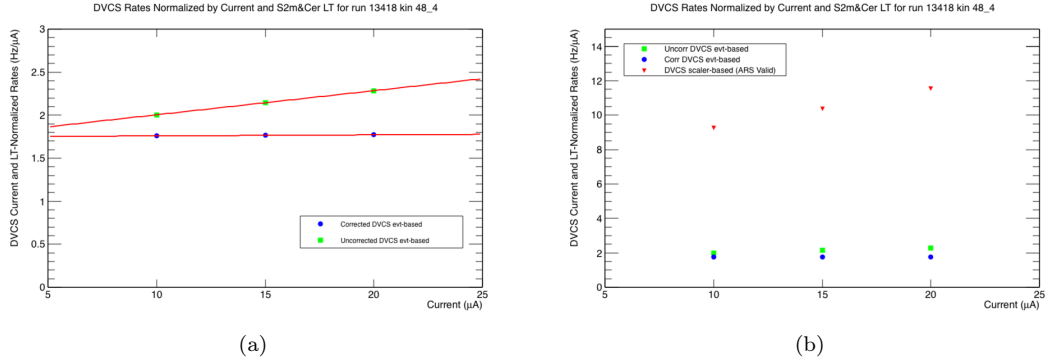

Figure 6: (a) DVCS normalized rates for **run 13418** at 10, 15, 20 μA shown before (green) and after the background subtraction with 6 ns main coincidence and accidental windows (blue): rates were corrected to agree better than 1%. (b) Plot comparing DVCS event-based rates and the previous DVCS scaler-based (ARS Valid) Rates. For the ARS Valid rate, the current and LT normalized DVCS rates had a 22% discrepancy per 10 μA and 11% per 5 μA .

6 Reproducibility of Deadtime correction for runs 12985 (15 μA) and 12901 (10 μA)

I have performed a step-by-step analysis and check of the deadtime correction and report the results in this section. Run 12985 and 12901 are part of kinematic 48_3 taken in Spring 2016 with a LH_2 target. These two runs were a good choice for the reproducibility check as they are in the same kinematic with varying current and fixed prescale factors. With 500K events in data stream, run 12985 was had an average of 15.81 μA beam current. Run 12901 had 300K events in the data stream and had an average of 10.86 μA beam current. It should be noted that 12985 also ran at 10 μA but statistics were too low to report results (about 100 events).

6.1 Trigger Rates and Livetime Agreement Check

6.2 Event-based Rate and Scaler-based rate Comparison

Hashir's correction of 1.057 for missed events from kinematic 48_3 was applied to each raw rate. The event-based and scaler-based (ARS Valid) raw rates are compared in Table 7.

6.3 Accidental Substraction

The trigger threshold⁷ for the blocks in the calorimeter for kinematic 48_3 was set to be 1.0073 GeV.

Rates and LT	Pedestal for run 12901 ($< 0.8\mu A$)	Run 12901 at 10.86 (μA)	Pedestal for run 12985 ($< 0.8\mu A$)	Run 12985 at 15.81 (μA)
S2m&Cer live (Hz)	13.70	136.0	12.64	204.8
S2m&Cer raw (Hz)	13.73	140.3	12.66	210.4
Master OR live (Hz)	19.41	137.6	19.01	206.1
Master OR raw (Hz)	19.45	140.3	19.04	211.9
S0 live (Hz)	104.5	1838	108.6	2694
S0 raw (Hz)	104.9	1878	108.8	2776
S2m live (Hz)	251.1	5898	249.3	8127
S2m raw (Hz)	251.9	5902	249.9	8320
S2m $\frac{live}{raw} = LT$	0.9969	0.9993	0.9974	0.9768
S0 $\frac{live}{raw} = LT$	0.9964	0.9785	0.9979	0.9703
Master OR $\frac{live}{raw} = LT$	0.9978	0.9811	0.9984	0.9725
S2m&Cer $\frac{live}{raw} = LT$	0.9979	0.9822	0.9981	0.9735

Table 6: Table for **runs 12901 and 12985** showing raw and live rates from triggers and livetimes for S2m&&Cer, Master OR, S0, S2m. All livetimes are pedestal subtracted, e.g raw and live rates when beam current is $< 0.8 \mu A$ and subtracted during the run. I used S2m&&Cer LT as the Livetime correction for DVCS rates.

Raw Rates	Ped for run 12901 ($< 0.8\mu A$)	Run 12901 at 10.86 μA	Ped for run 12985 ($< 0.8\mu A$)	Run 12985 at 15.81 μA
S2m&Cer LT	0.9979	0.9822	0.9981	0.9735
Event rate (Hz)	17.35	100.3	17.17	158.5
Event rate&Tracking Cut (Hz)	0.5632	62.42	0.1714	96.11
Event rate&Tracking&TDC&Cer (Hz)	0.5524	60.13	0.1414	92.62
Event rate&Tracking&TDC&Cer&PR&VtxCut (Hz)	0.3618	44.11	0.0352	67.72
Event rate&GoodEventCut&TDC (Hz)	0.1623	24.67	0.0260	38.03
Event rate&GoodEventCut&TDC&DIS (Hz)	0.1623	18.24	0.02591	26.57
ARS Valid rate (Hz)	16.61	93.13	15.99	147.91
GoodEventCut&TDC&DVCS (Hz)	0.1623	24.67	0.02591	38.03

Table 7: Table showing all pedestal subtracted raw rates with all cuts and corrections applied for runs 12901 and 12985. The "GoodEventCut" includes Track&TDC&Cer&PR&VtxCut&Rfunction cuts. All raw rates are normalized with the 103.7 kHz clock from LHRS in DVCS crate. DIS rates have GoodEventCut & TDC & DIS (triggerPatternWord) cuts applied, DVCS rates have GoodEventCut & TDC & DVCS (triggerPatternWord) cuts applied and have units Hz .

Normalized Rates	Run 12901 at 10.86 μA	Run 12985 at 15.81 μA
S2m&Cer LT	0.9822	0.9735
No cuts ($Hz/\mu A$)	9.233	10.02
Tracking Cut ($Hz/\mu A$)	6.096	6.079
Tracking&TDC&Cer ($Hz/\mu A$)	5.875	6.057
Tracking&TDC&Cer&PR&VtxCut ($Hz/\mu A$)	4.296	4.284
GoodEventCut&TDC ($Hz/\mu A$)	2.272	2.405
$\frac{GoodEventCut&TDC&DIS}{I}$ ($Hz/\mu A$)	1.682	1.695
$\frac{GoodEventCut&TDC&DIS}{I \times S2m \& Cer LT}$ ($Hz/\mu A$)	1.727	1.710
$\frac{ARS Valid Rate}{I}$ ($Hz/\mu A$)	8.576	9.355
$\frac{ARS Valid Rate}{I \times S2m \& Cer LT}$ ($Hz/\mu A$)	8.731	9.610
$\frac{GoodEventCut&TDC&DVCS}{I}$ ($Hz/\mu A$)	2.272	2.405
$\frac{GoodEventCut&TDC&DVCS}{I \times S2m \& Cer LT}$ ($Hz/\mu A$)	2.313	2.472

Table 8: Table showing all pedestal subtracted raw rates normalized by current and livetime for runs 12901 and 12985. The "GoodEventCut" includes Track&TDC&Cer&PR&VtxCut&Rfunction cuts. All raw rates are normalized with the 103.7 kHz clock from LHRS in DVCS crate. DIS rates have GoodEventCut & TDC & DIS (triggerPatternWord) cuts applied, DVCS rates have GoodEventCut & TDC & DVCS (triggerPatternWord) cuts applied and have units Hz . DIS normalized rates had a < 1% agreement per 5 μA , and DVCS normalized rates had a 7% agreement per 5 μA . Note that the normalized DIS rates have almost no current dependence, whereas the DVCS normalized rates do.

Time coincidence window cuts	10 μA	15 μA
Raw time coincidence window [-11,11]	1.986E4	3.017E4
4 ns, [-2,2] main coincidence window	1.178E4	1.581E4
4 ns, [-2,2] main coincidence window: <i>events/ns</i>	2787	3740
6 ns, [-3,3] main coincidence window	1.263E4	1.721E4
6 ns, [-3,3] main coincidence window: <i>events/ns</i>	2107	2869
6 ns, [-11,-5] accidental window	2201	3898
6 ns, [-11,-5] accidental window: <i>accidentals/ns</i>	366.8	649.7
4 ns, [-10,-6] accidental window	1849	3229
4 ns, [-10,-6] accidental window: <i>accidentals/ns</i>	462.2	807.3
6 ns, [5,11] accidental window	2219	4044
6 ns, [5,11] accidental window: <i>accidentals/ns</i>	369.8	674.0
4 ns, [6,10] accidental window	1822	3398
4 ns, [6,10] accidental window: <i>accidentals/ns</i>	455.6	849.6
6 ns, [5,11] & [-11,-5] mean	2210	3971
6 ns, [5,11] & [-11,-5] mean: <i>mean accidentals/ns</i>	368.3	661.9
4 ns, [-10,-6] & [6,10] mean	1835	3314
4 ns, [-10,-6] & [6,10] mean: <i>mean accidentals/ns</i>	458.9	828.4
6 ns mean accidentals & coincidences in [-3,3]: <i>signal/background</i>	0.8252	0.7693
4 ns mean accidentals & coincidences in [-2,2]: <i>signal/background</i>	0.8442	0.7904

Table 9: Table for runs **12901 and 12985** showing scaled and raw accidentals/ns of the accidental windows and the events/ns of the coincidence windows of 4 ns at [-2,2] and 6 ns at [-3,3] rounded to the nearest significant figure. The windows chosen for the correction of DVCS rates were the 4 ns main coincidence [-2,2], with the 4 ns mean accidentals. The scaling of events per ns did not affect the DVCS calculation as we only use the signal/background ratios to perform the subtraction of accidental contributions from DVCS rates.

I (μA)	DVCS Raw	$\frac{DVCS\ Raw}{I}$	$\frac{DVCS\ Raw}{I \times S2m \& Cer\ LT}$	$\frac{4\ ns\ signal}{4\ ns\ background}$	$\frac{DVCS\ Raw \times \frac{4\ ns\ signal}{4\ ns\ background}}{I \times S2m \& Cer\ LT}$	$\frac{6\ ns\ signal}{6\ ns\ background}$	$\frac{DVCS\ Raw \times \frac{6\ ns\ signal}{6\ ns\ background}}{I \times S2m \& Cer\ LT}$
10.86	24.67	2.272	2.313	0.8442	1.9525	0.8252	1.908
15.81	38.03	2.405	2.472	0.7904	1.9530	0.7693	1.901

Table 10: Table for runs **12901 and 12985** summarizing initial raw rates, normalized rates, and corrected rates. DVCS rates have GoodEventCut & TDC & DVCS (triggerPatternWord) cuts applied and normalized with the S2m & Cer livetime, and have units ($\frac{Hz}{\mu A}$). DVCS normalized rates had a 7% agreement per 5 μA . The DVCS with 4 ns time coincidence signal/background ratios applied to the DVCS normalized rates result 0.03% per 5 μA . The DVCS rates with the 6 ns time coincidence signal/background ratios applied to the DVCS normalized rates result in a discrepancy of 0.4% per 5 μA .

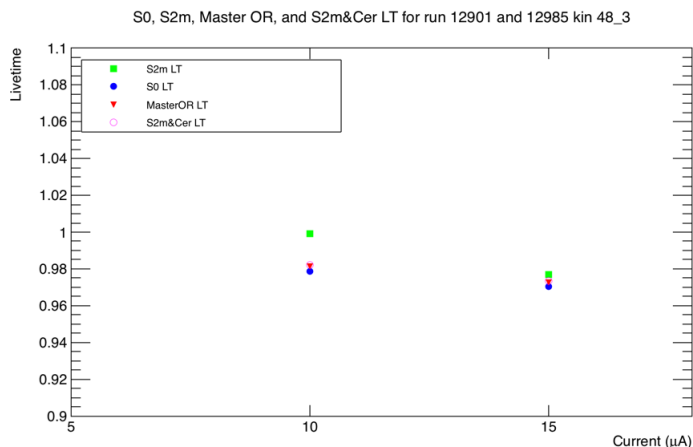

Figure 7: Livetimes of S2m, S0, Master OR and S2m&&Cer shown as a function of mean currents for **runs 12901 and 12985** at 10 and 15 μA .

7 Conclusions

Since the DVCS normalized rates were dependent on the current despite normalization with the current, the accidentals or random coincidences coming from the DVCS calorimeter and the Left High Resolution Spectrometer (LHRS) were subtracted from the DVCS rates to minimize the current dependence and recover the rates. Corrected DVCS rates from run 13418 are shown in Table 5 after the application of the signal/background ratios to eliminate the accidentals from the DVCS rates. **There is a 1.1 % agreement per 10 μA and 0.74% agreement 5 μA for run 13418 using the signal/background ratio with 6 ns windows.**

To check the DVCS rate recovery method used for run 13418, Runs 12985 (15 μA) and 12901 (10 μA) were analyzed the same way to verify reproducibility. As these runs had more statistics (300K to 500K) compared to run 13418 (100K), there was an even better agreement in accidental subtraction from DVCS normalized rates - **Run 12901 and 12985 had a discrepancy of 0.03% per 5 μA using the 4 ns time coincidence signal/background ratio, and 0.4% agreement using the 6 ns time coincidence signal/background ratio.** We can now confirm that procedure for checking the livetime correction from runs with beam current variation is reproducible. Thus, the livetime correction we have been applying to our DVCS rates, e.g. S2m & Cer LT, is properly applied to DVCS rates. A summary of these findings is shown in Figure 10.

The deadtime for DVCS rates in 13418 using Equation 8 is 1.9% for 10 μA , 2.9% for 15 μA , and 4.0% for 20 μA . For run 12901 at 10 μA , the deadtime is 1.8%, and for run 12985 at 15 μA , is 2.7%.

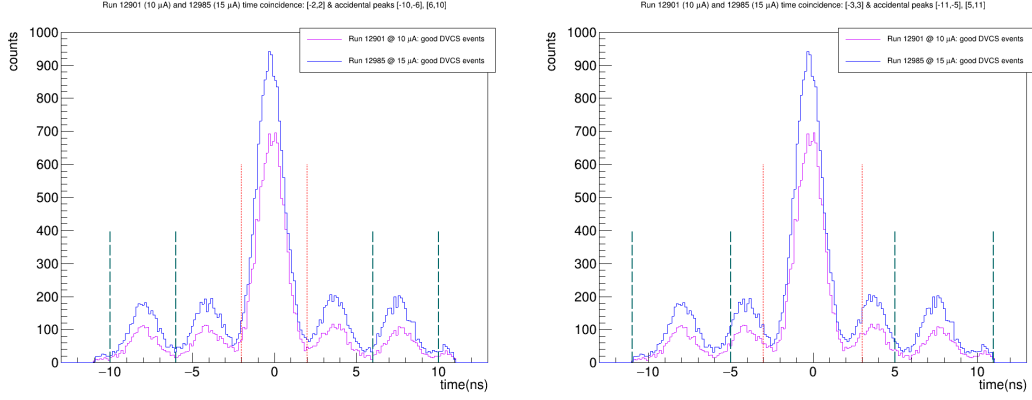

Figure 8: DVCS time coincidence spectra for runs **12985** and **12901** with all events passing the Good Event cut in the clustering. Main coincidence peaks are highlighted and shown at $[-3,3]$ and $[-2,2]$ for 10 and 15 μA . The events in this range is equivalent to the total amount of hits in the calorimeter including photons, electrons and background.

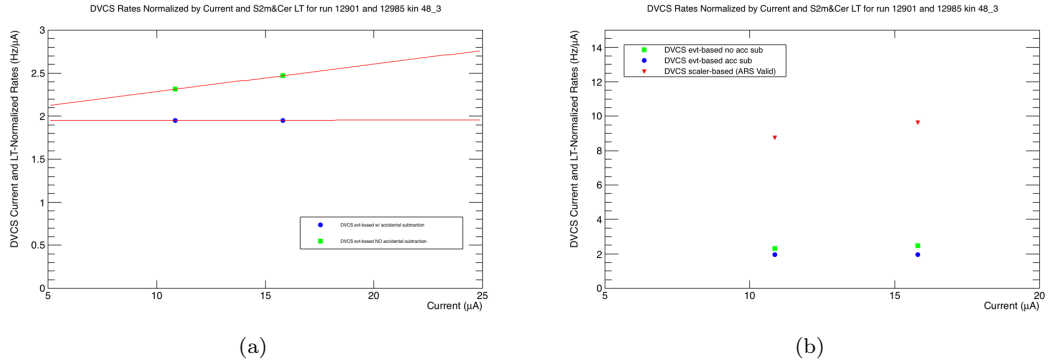

Figure 9: (a) DVCS normalized rates for runs **12901** and **12985** at 10 and 15 μA shown before (green) and after the background subtraction with 4 ns main coincidence and accidental windows (blue): rates were corrected to agree better than 1%. (b) Plot comparing DVCS event-based rates and the previous DVCS scaler-based (ARS Valid) Rates. For the ARS Valid rate, the current and LT normalized DVCS rates had a 9.6% discrepancy.

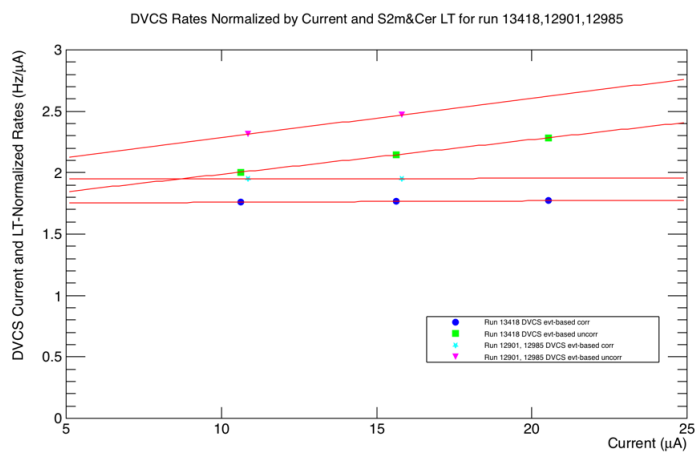

Figure 10: Summary of runs 13418, 12901, 12985 at 10, 15, 20 μA and the corresponding normalized uncorrected (no accidental subtraction) and corrected (accidental subtraction) DVCS rates.