

The background consists of numerous 3D-rendered numbers (0-9) in various sizes and orientations, creating a sense of depth and movement. The numbers are primarily in shades of light blue and white, with some darker blue accents. They are scattered across the frame, with some appearing more prominent than others.

Project
Update:
7/20/20

Sahnnee Shin

Intensity Ratio

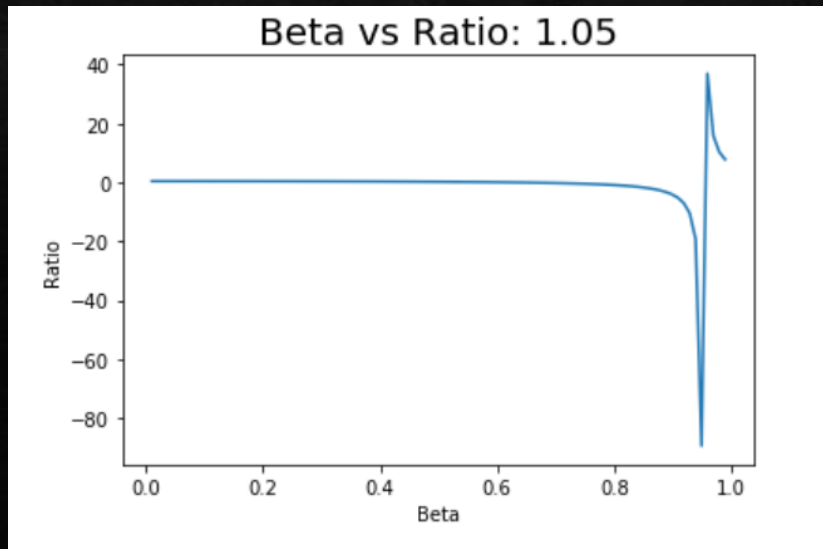
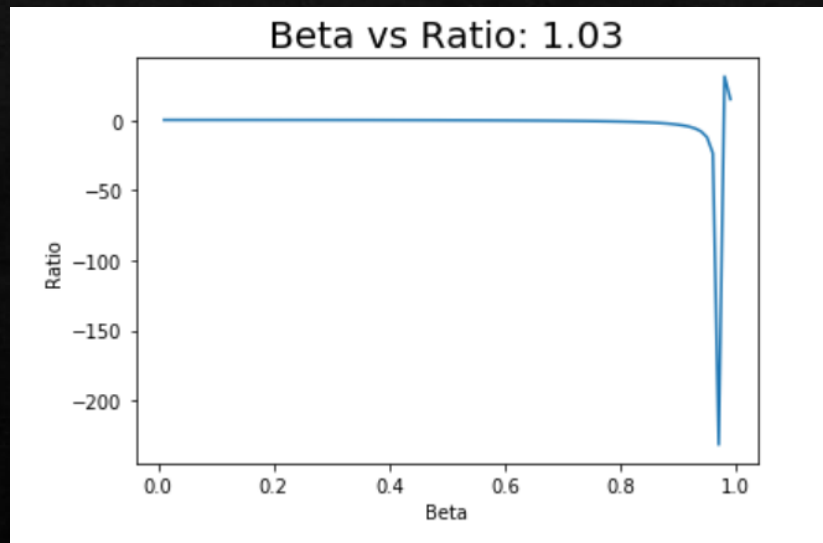
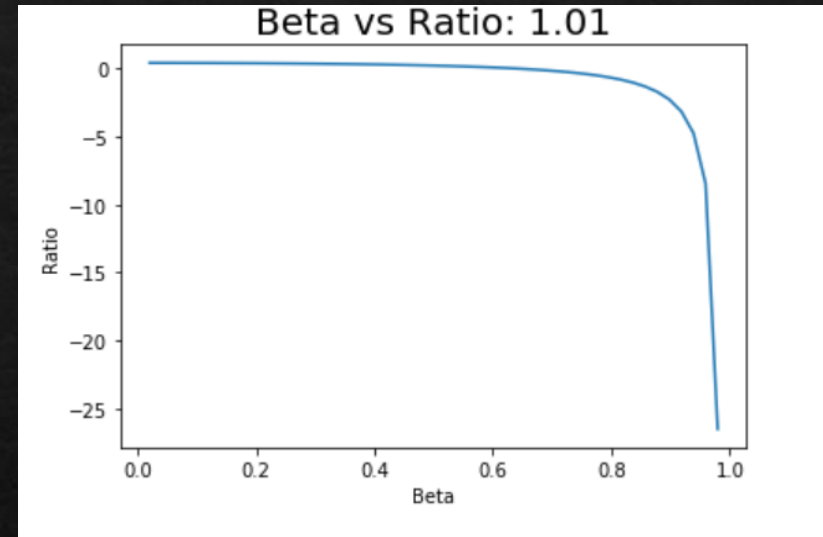
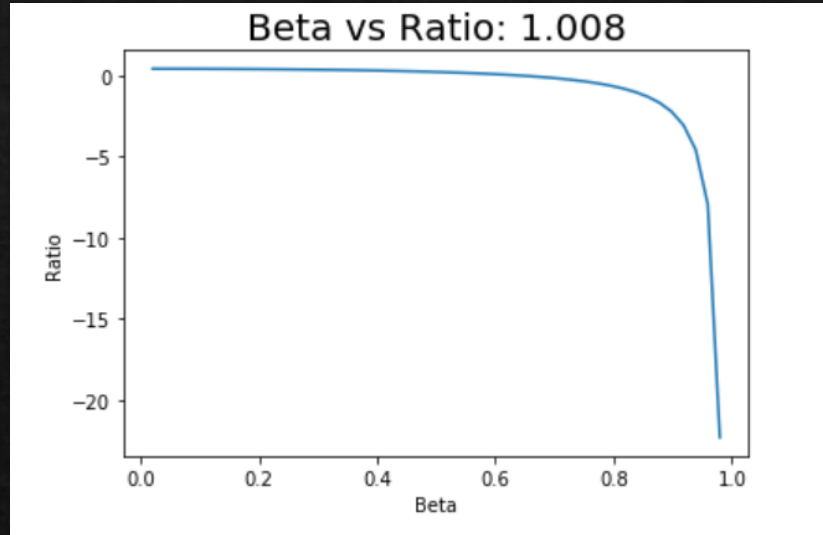

Linearized

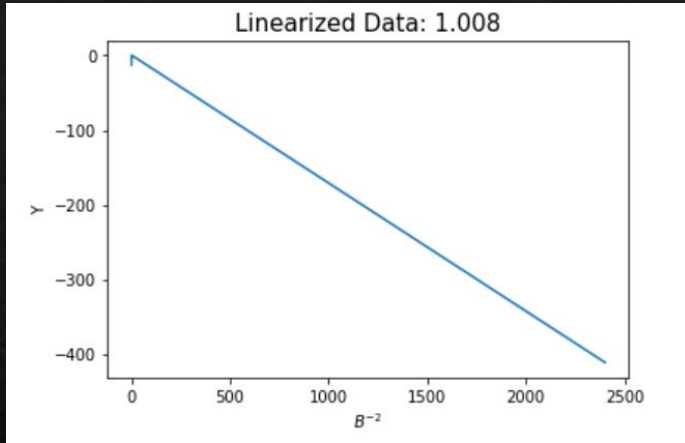

-0.1716

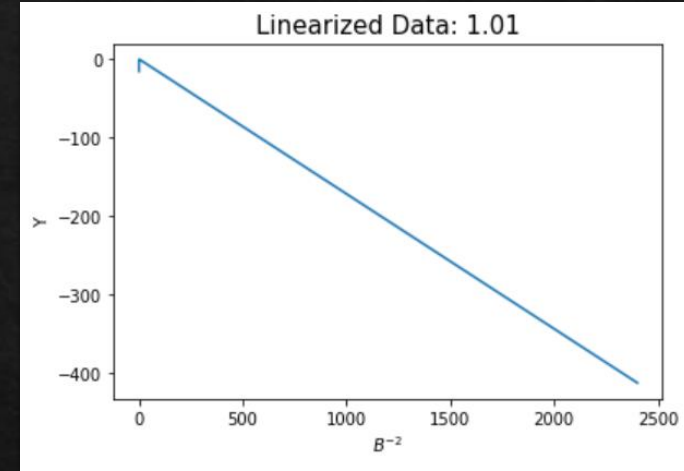

-0.1722

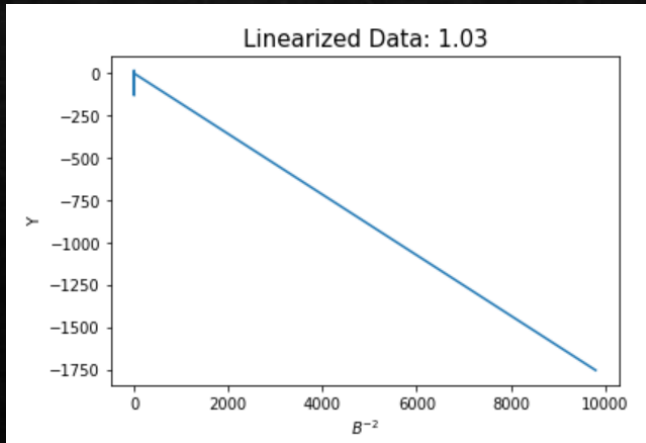

-0.1791

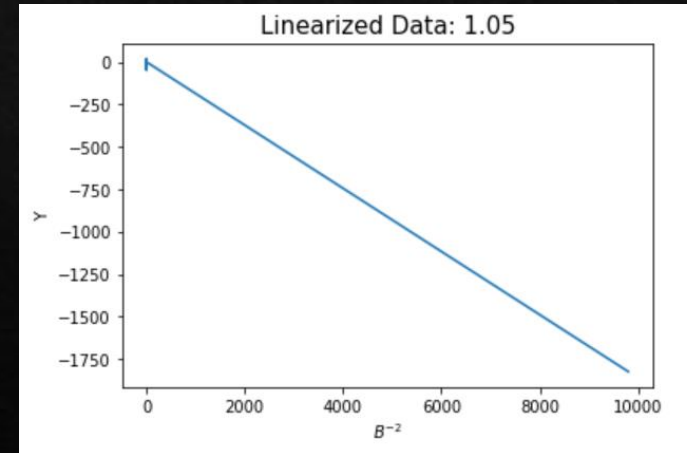

-0.1862

Autodesk
Inventor

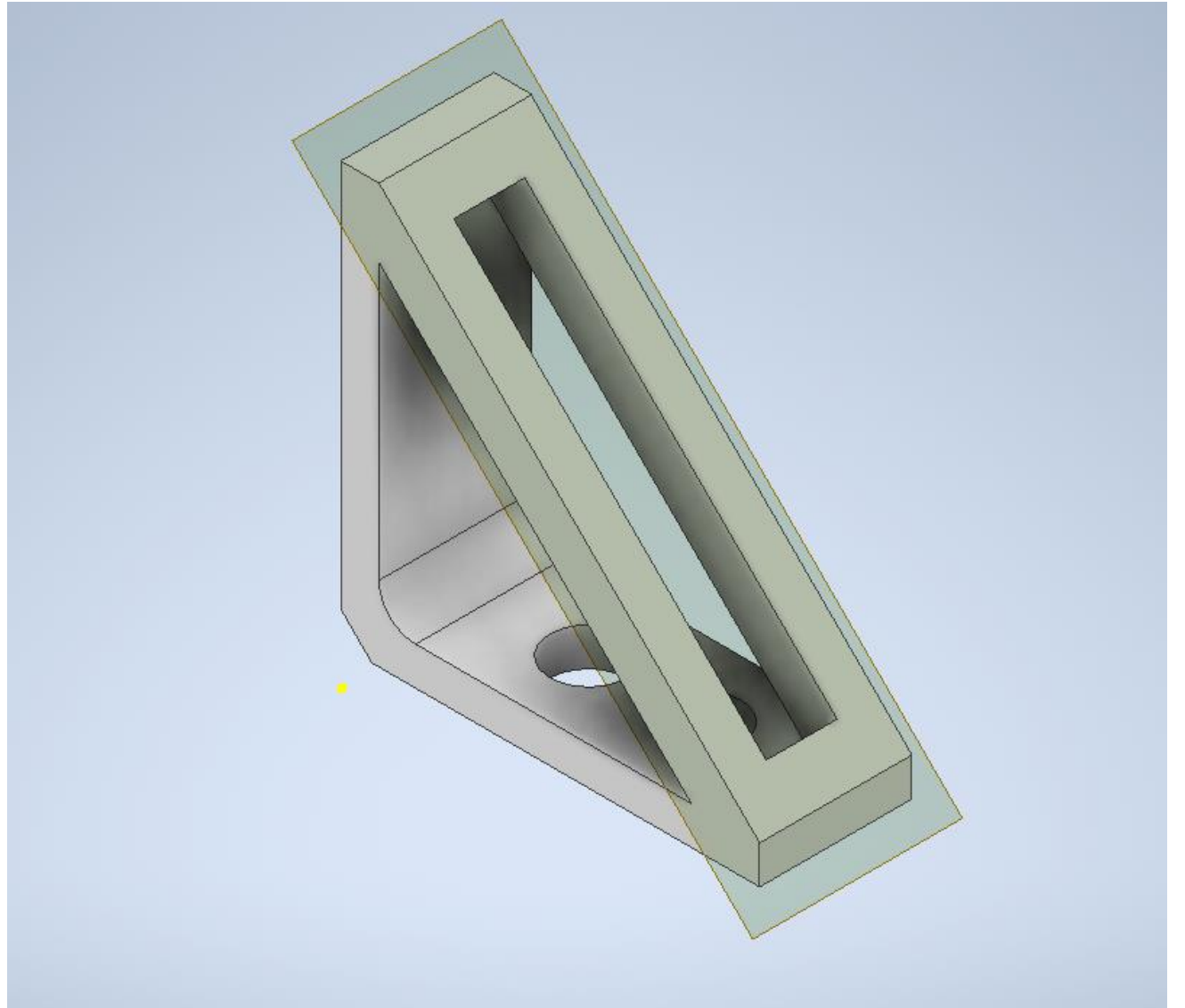

Outlook

- ◇ Practice more with Autodesk.
 - ◇ Try the aerogel and fiberglass modeling and stress analysis.
- ◇ Research ideal aerogel and fiberglass length.